

WORLD MARKET®

Assembly Instructions

ABBAY VELVET SWIVEL CHAIR

SKU 618954,629687

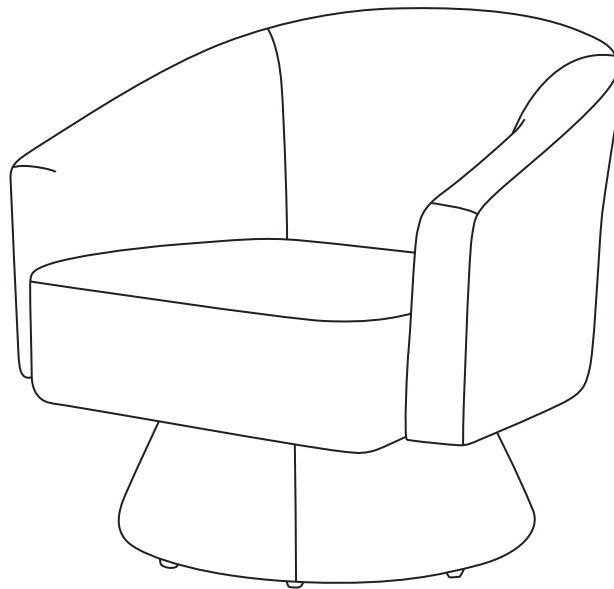



Thank you for your purchase. If you have any questions pertaining to the assembly of this furniture piece, please contact the nearest World Market store. If you are not near a store, please call our customer service call center toll free at 877-967-5362 for assistance.

ALL PRODUCTS SOLD AT WORLD MARKET ARE NOT
FOR COMMERCIAL USE AND ARE INTENDED FOR
RESIDENTIAL USE ONLY.

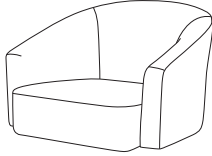
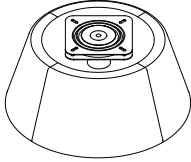
Component List

LABEL	PICTURE	DESCRIPTION	QTY
A		Seat	1
B		Swivel Base	1

Hardware List

LABEL	PICTURE	DESCRIPTION	QTY
H-1		Allen Bolt M6x50mm	4
H-2		Spring Washer M6mm	4
H-3		Flat Washer ϕ 6mm	4

Tool List

LABEL	PICTURE	DESCRIPTION	QTY
T-1		Allen Wrench (5mm)	1

Assembly Preparation

Before Beginning:

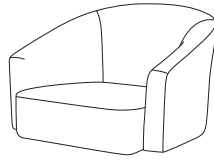

(A) x 1

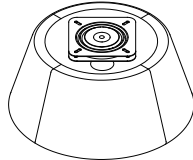

(B) x 1

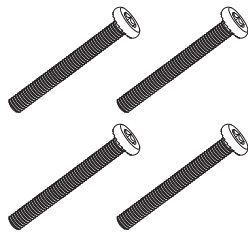

(H-1) x 4

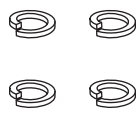

(H-2) x 4

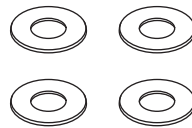

(H-3) x 4

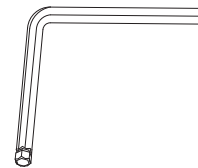

(T-1) x 1

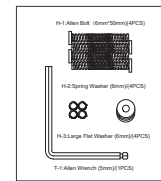

Unpack all hardware bags and components to ensure you have all parts. Take note of bolt hardware size differences and components that may have directional labels (Example: TOP or FRONT).



Read the assembly instructions, cover-to-cover. Save any **Care and Maintenance** instructions page for after the assembly has been completed.



It is always recommended to have 2 adults on hand for assembly.



Do not assembled on hard, abrasive flooring or carpeted surfaces that can damage or get caught in the components during assembly.

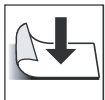

Assemble on a clean non-marring surface (such as the product's packing foam).

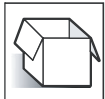

Do not discard any packaging until the product has been fully assembled.



In case of missing parts, please contact your nearest World Market store or call our customer service call center at 1-877-967-5362



WARNING: Small parts are a choking Hazard. Adult supervision is required before, during, and after assembly.

Assembly Steps

Step 1

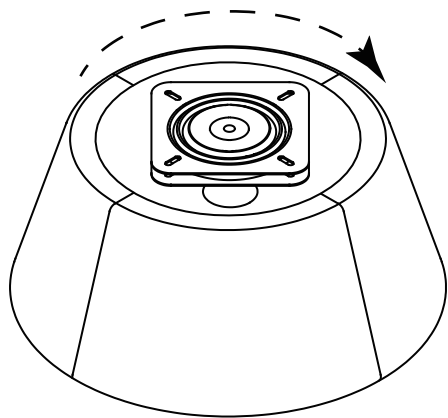

(B)

Rotate the swivel plate
by 45 degree first

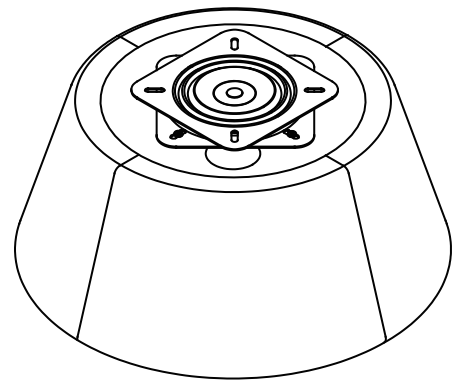



(B)

Rotate the metal swivel plate until holes for Allen Bolts (H-1) are exposed.

Assembly Steps

Step 2

-  (H-1) Allen Bolt M6×50mm×4
-  (H-2) Spring Washer M6mm×4
-  (H-3) Flat Washer φ6mm×4

Note: Align the four mounting holes on the top and bottom before placing B on the bottom of A

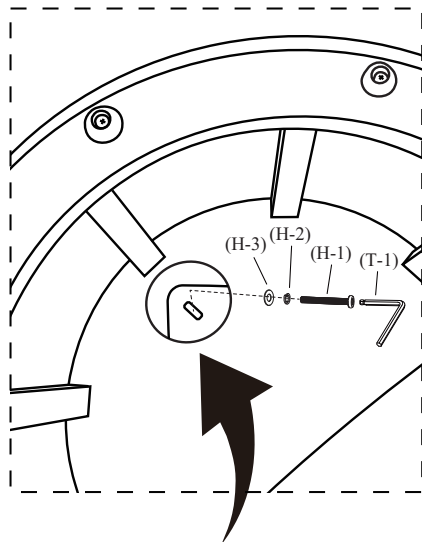

Note: Assemble by rotating the base to align the mounting holes

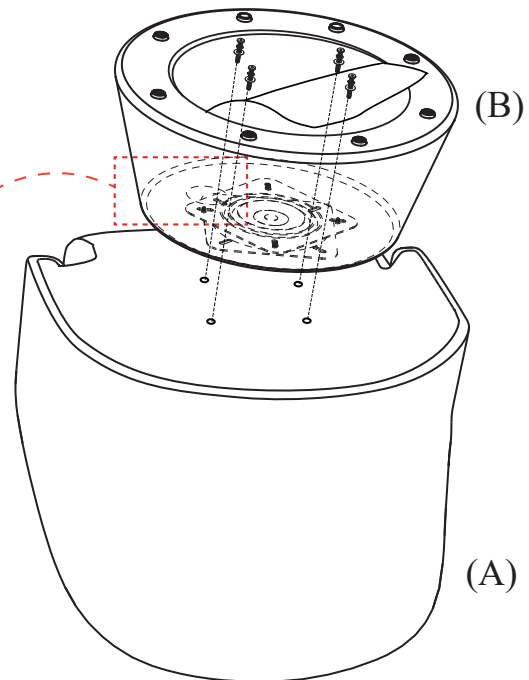

Align the four mounting holes on the Base (B) with the holes on the swivel plate, then place Base (B) onto the bottom of Seat (A), aligning receiving holes. Engage all Allen Bolts (H-1), Spring Washers (H-2) and Flat Washers (H-3) into receiving holes on Seat (A), stacking the hardware in the order as shown. Once all are engaged, fully tighten using provided Allen Wrench (T-1).

Assembly Steps

Step 4

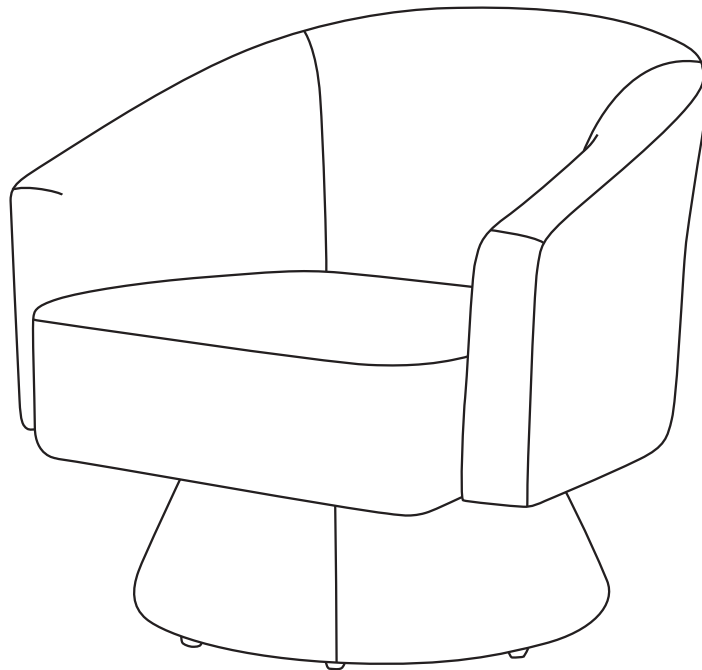

Assembly is completed and chair is ready for use.

ENSURE ALL BOLTS ARE FULLY TIGHTENED EVERY 3 MONTHS TO ENSURE STABILITY.

Warnings



All products sold at World Market are not for commercial use and are intended for residential use only.

Care & Maintenance



DO NOT put hot items directly on furniture surface.



DO NOT clean furniture with harsh cleansers or polish.



DO NOT place furniture in direct sunlight.



DO NOT place furniture near heating or cooling vents.



DO NOT write on furniture without a padded barrier to protect the surface.



DO NOT place furniture outside. For INDOOR USE ONLY.



Dust and pick up spills using a clean, non-colored, lint-free dry cloth.



Treat any spills or stains immediately. **DO NOT** let it soak into the fabric.



Solid and liquid stains can be spot cleaned using a clean white cotton cloth. We also recommend our Indoor Upholstery Cleaner (sold separately), Scan QR code below.

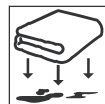

Dab the stain with light, even pressure. **DO NOT** rub the stain when spot cleaning.

SCAN HERE FOR
INDOOR UPHOLSTERY CLEANER



WORLD MARKET LIMITED ONE-YEAR WARRANTY – Indoor Furniture

For your customer satisfaction, this product carries a LIMITED ONE-YEAR WARRANTY from the date of delivery. This limited warranty only applies to World Market brand furniture, and not to other furniture brands sold on World Market's website.

Where applicable, the limited warranty provides coverage for:

- 1. Manufacturing, Material and Workmanship Defects:** Includes defects related to core frame/structure substrates (wood and metal); cracking, splitting, or complete breakage of hardwood, plywood or medium density fiberboard (MDF); cracking, splitting or lifting of wood veneer or laminated top surfaces caused by process failure; broken welds or improperly coated metal frame components (powder coating or painted); fabric or leather material defects including tears, misprints, fraying, crease marks, skip stitches or open seams; support webbing material and sinuous spring defects or damage, including method of attachment to frame; and other component failures that are a direct result of manufacturing or workmanship defects.
- 2. Cushions & Cushions with Enclosed Steel Pocket Coils:** Failed or ruptured steel pocket coils enclosed inside of seat cushions, or loss of resiliency from a material breakdown of foam or fiber filling, which should not be confused with softening or settling during normal use.
- 3. Leather: Splitting or cracking of leather material. NOTE:** The warranty does NOT cover natural hide markings, variations in the leather color or grain due to the authentic natural properties of processed cowhide leather.
- 4. Bonded Leather or Bi-cast Leather:** Separation of the polyurethane coating, peeling or cracking of the inner layer or at the bonded seam edges (bi-cast straps).
- 5. Furniture Components (Hardware & Mechanisms):** Includes defects to pre-installed components or hardware provided to the customer for assembly such as office chair hydraulic lifts, lift mechanisms, metal bases and casters, swivel plate mechanisms; for drawers, metal glides, handles/knobs; for doors, hinges, magnetic latches; and other components such as bent or stripped threaded leg posts and adjustable levelers. For missing, damaged, corroded, or misplaced hardware components such as bolts or washers, please contact Customer Service at: 877-967-5362.

This LIMITED ONE-YEAR WARRANTY does NOT cover:

1. Damage due to mishandling during transportation from store or transportation without original protective packaging.
2. Abuse, negligence (product misuse) or wear and tear that may result in or from:
 - a. Wood & Veneer:** Mishandling, exposure to moisture, peeling or discoloration caused by exposure to moisture or excessive sunlight, heat; splintered, dented or nicked panels, legs or component edges or paint/finish blemishes; or treatment with corrosive chemicals (dyes, inks, paints or harsh cleaning products).
 - b. Fabric & Leather (Including Bonded or Bi-Cast Leathers):** cuts, punctures, tears, burns, pet damage, or treatment with corrosive chemicals (dyes, inks, paints or harsh cleaning products), exposure to direct sunlight, fire, high heat, water, or any bright light source (natural or artificial) that may cause splitting, peeling or flaking with time.
 - c. Foam (Cushions):** Flattening, relaxing or settling/softening of foam components that comes with normal use.
 - d. Hardware Components:** improper installation or misuse/substitution of hardware components not defined in the Assembly Instructions for the product (if applicable)
3. Damage due to environmental exposure to direct sunlight, fire, high heat, water or extreme humidity, any bright light source (natural or artificial), or any environment that the product is not intended for.
4. This warranty is applicable for indoor furniture products purchased for residential use only.

For additional information on returns, please visit: <https://www.worldmarket.com/category/customer-service/returns.do>

All products sold at World Market are NOT FOR COMMERCIAL USE and are intended for residential use only. Products purchased for commercial use will VOID all warranty provisions as listed above.

Any claims under this LIMITED ONE-YEAR WARRANTY are valid and applicable only as to the original purchaser and must be accompanied by proof of purchase. Warranty claims should be submitted to a World Market store or through World Market Customer Service Call Center, Toll Free at 877-967-5362.

For valid warranty claims, World Market will repair or replace the product, or offer a full or partial credit, in the sole discretion of World Market. This LIMITED ONE-YEAR WARRANTY gives you specific legal rights and you may also have other rights which vary from state to state.

(INDOOR FURNITURE 1LW_v1.6_071423)